

ASSEMBLY INSTRUCTIONS

Oval Dining Table

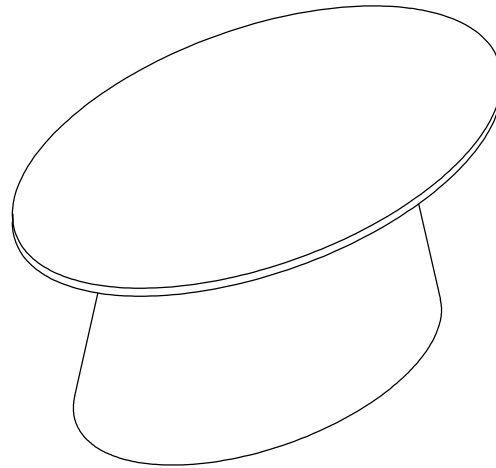

CHAPEL·HILL





Please read below before assembly

- Assemble the product on a flat, soft surface such as a carpet or cloth to prevent scratching the finish.
- Do not discard any content until assembly is complete to avoid accidentally discarding small parts or hardware.
- Take out all parts and hardware from box.
- Failure to follow these instructions may cause the bolts to misalign during assembly.

DISCLAIMERS:

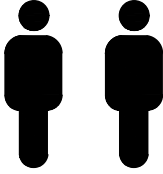
- WHEN PROPERLY ASSEMBLED, THIS ITEM IS SAFE FOR INTENDED USE. SELLER IS NOT LIABLE FOR ANY DAMAGES RESULTING FROM ITEM BEING IMPROPERLY ASSEMBLED AFTER PURCHASE.
- BOLTS MAY LOOSEN DURING NORMAL EVERYDAY USE. THEY SHOULD BE INSPECTED AT LEAST EVERY 3 MONTHS AND RE-TIGHTENED AS NEEDED TO PREVENT DAMAGE OR INJURY AND ENSURE STABILITY.

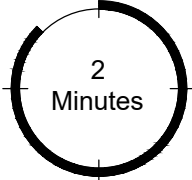
 <p>PEOPLE</p>	 <p>100 lbs top WEIGHT LIMIT</p>	 <p>2 Minutes ESTIMATED TIME</p>
---	---	---



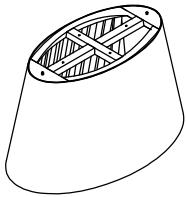
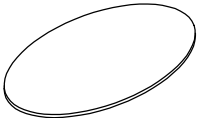

Important safety Instructions :

- Please carefully read all instructions before assembling.
- For your safety, assembly by two or more adults is recommended.
- Keep instructions for furniture use.

PART LIST

Item	Description		QTY
P1	Base		1 Pc
P2	Top		1 Pc

HARDWARE LIST

Item	Description		QTY
H1	Bolt M8 x 40mm		4 Pcs
H2	Spring Washer		4 Pcs
H3	Flat Washer		4 Pcs
H4	Allen Key L4		1 Pc

ASSEMBLY STEP

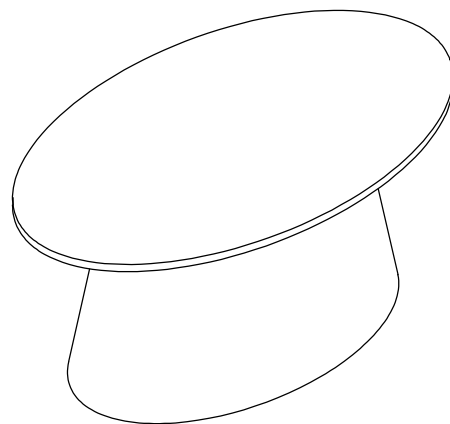
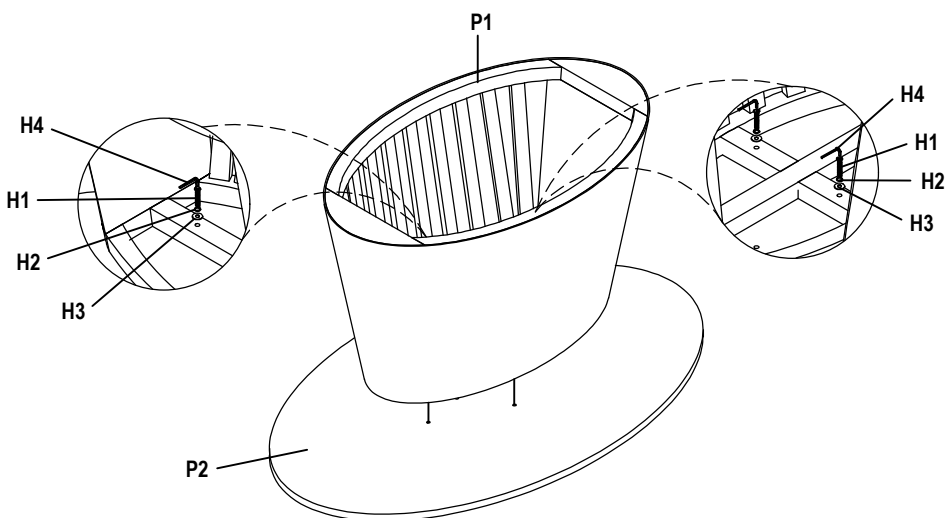

Care & Maintenance

Do...



Wipe up spills immediately.



Dust and pick-up spills using a clean, non-colored, lint-free, dry cloth.



Use mild non-abrasive soap and water.

Don't...



Do not put hot items directly on furniture surface.



Do not clean furniture with harsh cleansers or polish.



Do not place furniture in direct sunlight.



Do not place furniture near heating or cooling vents.



Do not write on furniture without a padded barrier to protect the surface.



Do not place furniture outside. For indoor use only.