







VICTORIA SMALL DRESSER

Assembly instructions:

PARTS LIST

No.	DESCRIPTION	IMAGE	QTY
P1	CABINET BODY		1
P2	LEG		4
P3	TILT KIT BRACKET		1

HARDWARE LIST

No.	DESCRIPTION	IMAGE	QTY
H1	BOLT		8
H2	SPRING WASHER		8
H3	FLAT WASHER		8
H4	ALLEN KEY		1

NOTE: PO# is located underneath/ inside of each item. Please be prepared to provide this # should any claim be necessary.

CAUTION: Item is heavy assembly should be performed by two people.

1

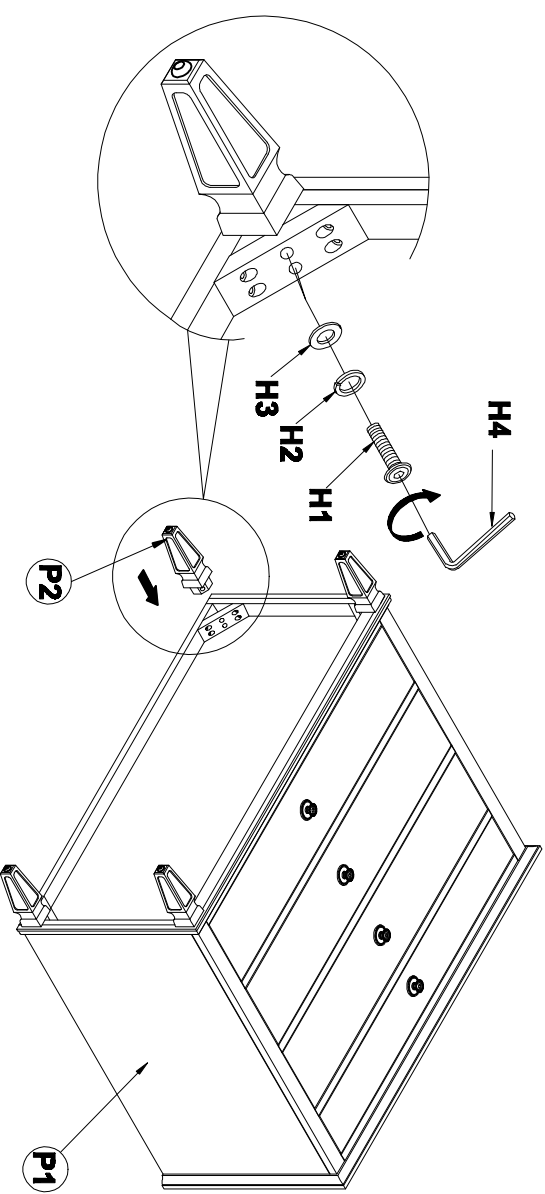

2

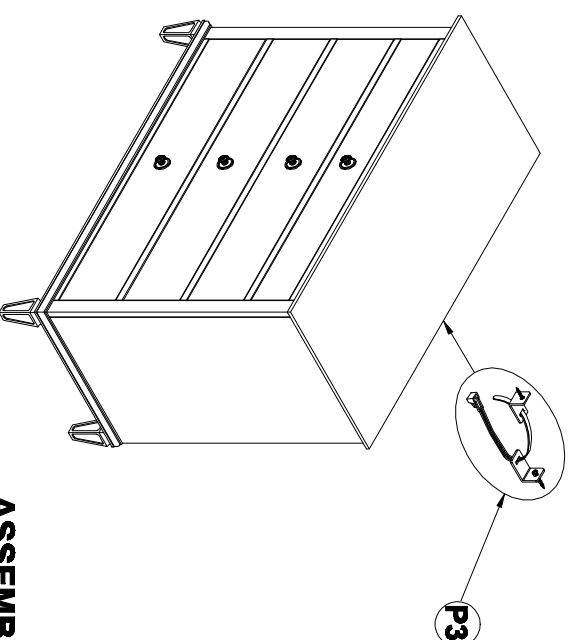

ASSEMBLED COMPLETE